

EC1145-3.088M

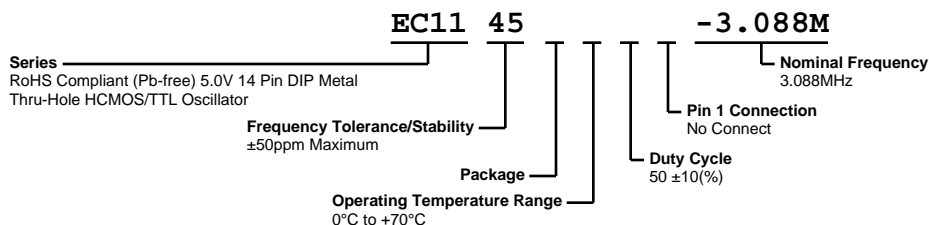

ELECTRICAL SPECIFICATIONS

Nominal Frequency	3.088MHz
Frequency Tolerance/Stability	±50ppm Maximum (Inclusive of all conditions: Calibration Tolerance at 25°C, Frequency Stability over the Operating Temperature Range, Supply Voltage Change, Output Load Change, First Year Aging at 25°C, Shock, and Vibration)
Aging at 25°C	±5ppm/year Maximum
Operating Temperature Range	0°C to +70°C
Supply Voltage	5.0Vdc ±10%
Input Current	45mA Maximum
Output Voltage Logic High (Voh)	2.4Vdc Minimum with TTL Load, Vdd-0.5Vdc Minimum with HCMOS Load
Output Voltage Logic Low (Vol)	0.4Vdc Maximum with TTL Load, 0.5Vdc Maximum with HCMOS Load
Rise/Fall Time	6nSec Maximum (Measured at 0.4Vdc to 2.4Vdc with TTL Load, at 20% to 80% of waveform with HCMOS Load)
Duty Cycle	50 ±10(%) (Measured at 1.4Vdc with TTL Load or at 50% of waveform with HCMOS Load)
Load Drive Capability	10TTL or 50pF HCMOS Load
Output Logic Type	CMOS
Pin 1 Connection	No Connect
Tri-State Input Voltage (Vih and Vil)	+2.2Vdc Minimum to enable output, +0.8Vdc to disable output (High Impedance), No connect to enable output.
Absolute Clock Jitter	±100pSec Maximum
One Sigma Clock Period Jitter	±25pSec Maximum
Start Up Time	10mSec Maximum
Storage Temperature Range	-55°C to +125°C

ENVIRONMENTAL & MECHANICAL SPECIFICATIONS

Fine Leak Test	MIL-STD-883, Method 1014, Condition A
Gross Leak Test	MIL-STD-883, Method 1014, Condition C
Lead Integrity	MIL-STD-883, Method 2004
Mechanical Shock	MIL-STD-202, Method 213, Condition C
Resistance to Soldering Heat	MIL-STD-202, Method 210
Resistance to Solvents	MIL-STD-202, Method 215
Solderability	MIL-STD-883, Method 2003
Temperature Cycling	MIL-STD-883, Method 1010
Vibration	MIL-STD-883, Method 2007, Condition A

EC1145-3.088M

MECHANICAL DIMENSIONS (all dimensions in millimeters)



PIN	CONNECTION
1	No Connect
7	Ground/Case Ground
8	Output
14	Supply Voltage

LINE	MARKING
1	ECLIPTEK
2	EC11 EC11=Product Series
3	3.088M
4	XXYYZ XX=Ecliptek Manufacturing Code Y=Last Digit of Year ZZ=Week of Year

OUTPUT WAVEFORM

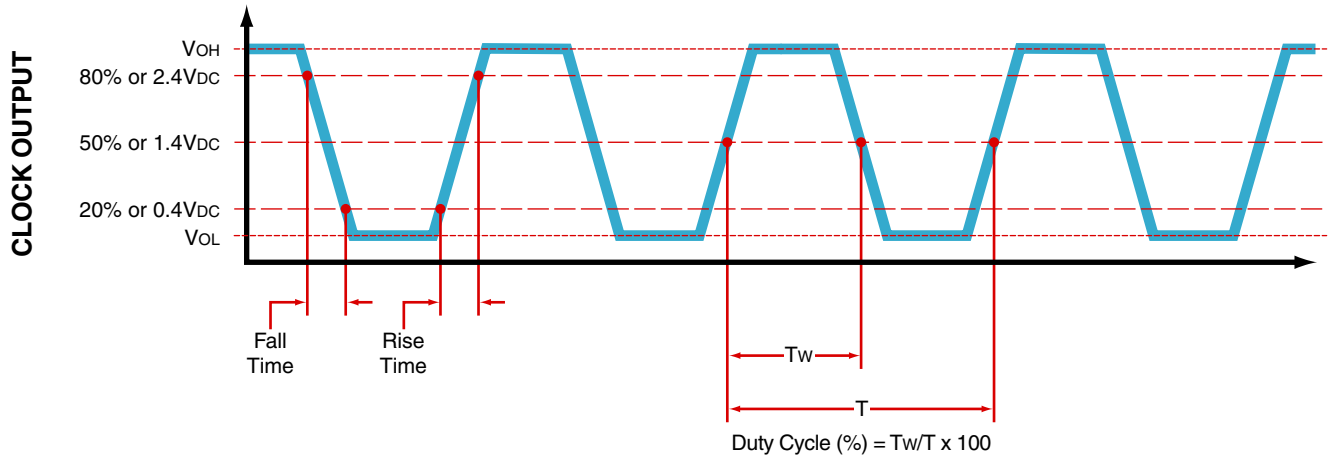

EC1145-3.088M

Test Circuit for TTL Output

Output Load Drive Capability	R _L Value (Ohms)	C _L Value (pF)
10TTL	390	15
5TTL	780	15
2TTL	1100	6
10LSTTL	2000	15
1TTL	2200	3

Table 1: R_L Resistance Value and C_L Capacitance Value Vs. Output Load Drive Capability

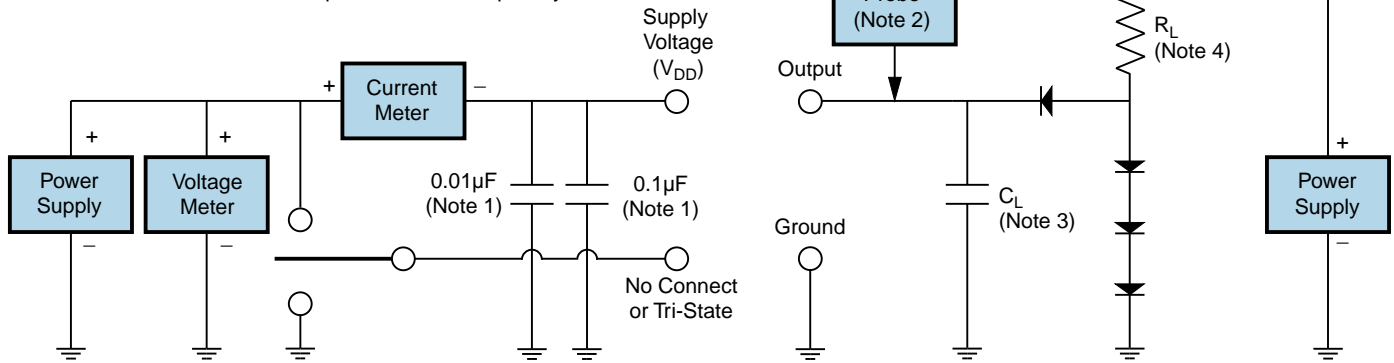

- Note 1: An external 0.1μF low frequency tantalum bypass capacitor in parallel with a 0.01μF high frequency ceramic bypass capacitor close to the package ground and V_{DD} pin is required.
- Note 2: A low capacitance (<12pF), 10X attenuation factor, high impedance (>10Mohms), and high bandwidth (>300MHz) passive probe is recommended.
- Note 3: Capacitance value C_L includes sum of all probe and fixture capacitance.
- Note 4: Resistance value R_L is shown in Table 1. See applicable specification sheet for 'Load Drive Capability'.
- Note 5: All diodes are MMBD7000, MMBD914, or equivalent.

EC1145-3.088M

Test Circuit for CMOS Output



Note 1: An external $0.1\mu\text{F}$ low frequency tantalum bypass capacitor in parallel with a $0.01\mu\text{F}$ high frequency ceramic bypass capacitor close to the package ground and V_{DD} pin is required.

Note 2: A low capacitance ($<12\text{pF}$), 10X attenuation factor, high impedance ($>10\text{Mohms}$), and high bandwidth ($>300\text{MHz}$) passive probe is recommended.

Note 3: Capacitance value C_L includes sum of all probe and fixture capacitance.

Recommended Solder Reflow Methods



High Temperature Solder Bath (Wave Solder)

T_s MAX to T_L (Ramp-up Rate)	3°C/second Maximum
Preheat	
- Temperature Minimum (T _s MIN)	150°C
- Temperature Typical (T _s TYP)	175°C
- Temperature Maximum (T _s MAX)	200°C
- Time (t _s MIN)	60 - 180 Seconds
Ramp-up Rate (T_L to T_p)	3°C/second Maximum
Time Maintained Above:	
- Temperature (T _L)	217°C
- Time (t _L)	60 - 150 Seconds
Peak Temperature (T_p)	260°C Maximum for 10 Seconds Maximum
Target Peak Temperature (T_p Target)	250°C +0/-5°C
Time within 5°C of actual peak (t_p)	20 - 40 seconds
Ramp-down Rate	6°C/second Maximum
Time 25°C to Peak Temperature (t)	8 minutes Maximum
Moisture Sensitivity Level	Level 1
Additional Notes	Temperatures shown are applied to back of PCB board and device leads only. Do not use this method for product with the Gull Wing option.

Recommended Solder Reflow Methods



Low Temperature Infrared/Convection 185°C

T_s MAX to T_L (Ramp-up Rate)	5°C/second Maximum
Preheat	
- Temperature Minimum (T _s MIN)	N/A
- Temperature Typical (T _s TYP)	150°C
- Temperature Maximum (T _s MAX)	N/A
- Time (t _s MIN)	60 - 120 Seconds
Ramp-up Rate (T_L to T_p)	5°C/second Maximum
Time Maintained Above:	
- Temperature (T _L)	150°C
- Time (t _L)	200 Seconds Maximum
Peak Temperature (T_p)	185°C Maximum
Target Peak Temperature (T_p Target)	185°C Maximum 2 Times
Time within 5°C of actual peak (t_p)	10 seconds Maximum 2 Times
Ramp-down Rate	5°C/second Maximum
Time 25°C to Peak Temperature (t)	N/A
Moisture Sensitivity Level	Level 1
Additional Notes	Temperatures shown are applied to body of device. Use this method only for product with the Gull Wing option.

Recommended Solder Reflow Methods



Low Temperature Solder Bath (Wave Solder)

T_S MAX to T_L (Ramp-up Rate)	5°C/second Maximum
Preheat	
- Temperature Minimum (T _S MIN)	N/A
- Temperature Typical (T _S TYP)	150°C
- Temperature Maximum (T _S MAX)	N/A
- Time (t _s MIN)	30 - 60 Seconds
Ramp-up Rate (T_L to T_P)	5°C/second Maximum
Time Maintained Above:	
- Temperature (T _L)	150°C
- Time (t _L)	200 Seconds Maximum
Peak Temperature (T_P)	245°C Maximum
Target Peak Temperature (T_P Target)	245°C Maximum 1 Time / 235°C Maximum 2 Times
Time within 5°C of actual peak (t_p)	5 seconds Maximum 1 Time / 15 seconds Maximum 2 Times
Ramp-down Rate	5°C/second Maximum
Time 25°C to Peak Temperature (t)	N/A
Moisture Sensitivity Level	Level 1
Additional Notes	Temperatures shown are applied to back of PCB board and device leads only. Do not use this method for product with the Gull Wing option.

Low Temperature Manual Soldering

185°C Maximum for 10 seconds Maximum, 2 times Maximum. (Temperatures listed are applied to device leads only. This method can be utilized with both Gull Wing and Non-Gull Wing devices.)

High Temperature Manual Soldering

260°C Maximum for 5 seconds Maximum, 2 times Maximum. (Temperatures listed are applied to device leads only. This method can be utilized with both Gull Wing and Non-Gull Wing devices.)